



CONDENSING TANKLESS GAS WATER HEATER



Owner's Guide

Models

NRCP111-DV / NRCP98-DV

- Natural Gas(NG) / Liquid Propane Gas (LP)



Low NOx Approved
by SCAQMD
14ng/J or 20ppm
(Natural Gas Only)



Thank you for purchasing this Noritz Tankless Gas Water Heater.

Before using, please:

Read this guide completely for operation instructions.

Completely fill out the warranty registration card (included separately) and mail the detachable portion to Noritz America Corporation. Keep this guide (and the remainder of the warranty registration card) where it can be found whenever necessary.

Installation must conform with local codes, or in the absence of local codes, the National Fuel Gas Code, ANSI Z223.1/NFPA 54- latest edition and/or CSA B149.1, Natural Gas and Propane Installation Code (NSCNGPIC).

Noritz America reserves the right to discontinue, or change at any time, the designs and/or specifications of its products without notice.

WARNING

If the information in these instructions is not followed exactly, a fire or explosion may result, causing property damage, personal injury, or death.

- Do not store or use gasoline or other flammable vapors and liquids in the vicinity of this or any other appliance.
- WHAT TO DO IF YOU SMELL GAS
 - Do not try to light any appliance.
 - Do not touch any electrical switch; do not use any phone in your building.
 - Immediately call your gas supplier from a neighbor's phone. Follow the gas supplier's instructions.
 - If you cannot reach your gas supplier, call the fire department.
- Installation and service must be performed by a qualified installer, service agency or the gas supplier.

Owner's Guide – Table of Contents

<u>Chapter 1</u>	Safety Regulations.	Safety Precautions	3
		Before Operation	6
		When in Operation	6
		Important Safety Information	7
<u>Chapter 2</u>	Unit Operation	Initial Operation	8
		Control Panel Interface	9
		Control Panel LCD Interface	10
		How to use Control Panel	
		1. Clock Adjustment	11
		2. Setting Hot Water Temperature	12
		3. Locking the Control Panel	14
		4. How to check the 'Error History'	14
		5. How to check the 'Running History'	15
		6. Setting the 'Unit'	16
		7. Recirculation Timer Setup. (Recirculation Mode)	17
		Recirculation _Auto Mode	19
		Recirculation_Program Mode	20
		Recirculation Initialization	22
		8. Setting the 'Recirculation System'	23
		Recirculation Mode Setting	25
		9. Preventing Damage from Freezing-1	26
		10. Preventing Damage from Freezing-2	28
<u>Chapter 3</u>	Maintenance	1. General Maintenance	29
		2. Cleaning the Water Heater	30
		3. Flushing the Water Heater	32
		4. Checking for Error Conditions	34
<u>Chapter 4</u>	Troubleshooting	Troubleshooting	35
<u>Chapter 5</u>	Follow-up Service	Follow-up Service	36
	Memo		37

Safety Precautions

To avoid product damage, personal injury, or even possible death, carefully read, understand, and follow all the instructions in the Installation and Owner's Guide and on the Water Heater before installation, operation, or service.

Noritz cannot anticipate every circumstance that might involve a potential hazard and our warnings are, therefore, not all-inclusive. Proper installation, operation, and service are your responsibility.

You must be satisfied that the operation and settings of the Water Heater are safe for you and for others.

Safety Symbols are provided in the guide. When a user fails to adhere to the following requirements, it can cause death, serious damage, and a great property loss. For safety symbols, 'DANGER', 'WARNING', 'CAUTION' are indicated and the definitions for these terms are below :

DANGER

Indicates an imminently hazardous situation which, if not avoided, will result in death or serious injury. This signal word is limited to the most extreme situations.

WARNING

Indicates a potentially hazardous situation which, if not avoided, could result in death or serious injury.

CAUTION

Indicates a potentially hazardous situation which, if not avoided, may result in minor or moderate injury. It is also used to alert against unsafe practices and hazards involving only property damage.

WARNING

FOR YOUR SAFETY READ BEFORE OPERATING

If you do not follow these instructions exactly, a fire or explosion could result causing property damage, personal injury or loss of life.

- A. This appliance does not have a pilot. It is equipped with an ignition device which automatically lights the burner. Do not try to light the burner by hand.
- B. BEFORE OPERATING smell all around the appliance area for gas. Be sure to smell next to the floor because some gas is heavier than air and will settle on the floor.

WHAT TO DO IF YOU SMELL GAS

- Do not try to light any appliance.
- Do not touch any electric switch; do not use any phone in your building.
- Immediately call your gas supplier from a neighbor's phone. Follow the gas supplier's instructions.
- If you cannot reach your gas supplier, call the fire department.
- C. Use only your hand to push in or turn the gas control knob. Never use tools. If the knob will not push in or turn by hand, don't try to repair it, call a qualified service technician. Force or attempted repair may result in a fire or explosion.
- D. Do not use this appliance if any part has been under water. Immediately call a qualified service technician to inspect the appliance and to replace any part of the control system and any gas control which has been under water.

WARNING

TO TURN OFF GAS TO APPLIANCE

1. Set the thermostat to lowest setting.
2. Turn off all electric power to the appliance if service is to be performed.
3. Turn manual gas shutoff valve to "OFF" position

Safety Precautions

⚠ WARNING

OPERATING INSTRUCTIONS

1. STOP! Read the safety information above on this label.
2. Set the thermostat to lowest setting.
(Do not use Water Heater unless it is completely filled with water.)
3. Turn OFF electrical power supply to the Water Heater.
4. This Water Heater is equipped with an ignition device which automatically lights the main burner. Do not try to light the burner by hand.
5. Turn gas shut-off valve clockwise to "OFF" position. Do not force
6. Wait five (5) minutes to clear out any gas. If you then smell gas, STOP! Follow step "B" above on this label. If you don't smell gas, go to next step.
7. Turn manual gas shut-off valve to "ON" position.
8. Turn ON electrical power to the appliance.
9. Wait until default temperature (120°F) is displayed. Set desired water temperature. Turn hot water faucet on.
10. Set thermostat to desired setting.
11. If the appliance will not operate, follow the instructions "To Turn Off Gas To Appliance" and call your service technician or gas supplier.

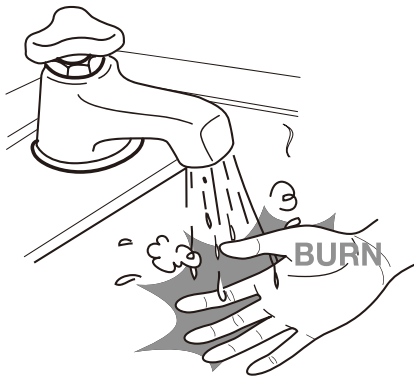

⚠ DANGER

Use this Water Heater at your own risk. The outlet temperature of the Noritz Water Heater is factory preset to 120°F (49°C). The temperature can only be changed by using the control panel. Hot water temperature over 125°F (52°C) can cause severe burns instantly or death from scalding. Children, disabled, and elderly are at the highest risk of being scalded. Do not leave children or the infants unsupervised. Check temperature of hot water before taking a shower or bath. To control water temperature to a particular faucet, temperature limiting valves can be installed by your service professional.

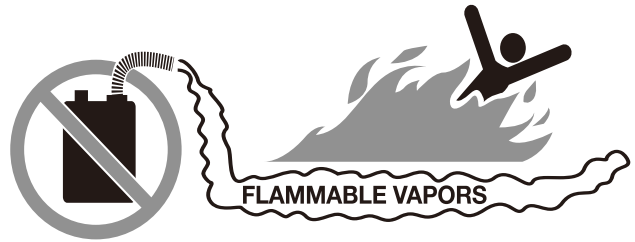

⚠ DANGER

■ Vapors from flammable liquids will explode and catch fire causing death or severe burns.
Do not use or store flammable products such as gasoline, solvents or adhesives in the same room or area near the appliance.

Keep flammable products :

- Far away from Water Heater
- In approved containers
- Tightly closed
- Out of children's reach

Vapors

- Cannot be seen
- Vapors are heavier than air
- Go a long way on the floor
- Can be carried from other rooms to the main burner by air currents

Do not install the appliance where flammable products will be stored.
Read and follow Water Heater warnings and instructions. If owner's guide is missing contact the retailer or manufacturer.

Safety Precautions

⚠ WARNING

- Proper care is your responsibility. Carefully read and understand the Operating Information in this guide before operating the Noritz Water Heater.
- Be fully aware of where the gas shut-off valve is located and how to operate it.
Close the gas shut-off valve immediately if the appliance is subjected to fire, overheating, flood, physical damage, or any other damaging condition that might affect the operation of the unit.
The Water Heater must be checked by a qualified technician before resuming operation.
- DO NOT use this Water Heater if any part has been under water, call a qualified technician immediately for inspecting the Water Heater and for replacing any part of the control system and any gas control which has been under water.
- Do not power up the unit unless the gas and water supply valves are fully opened. Make sure that fresh air intake flue and exhaust gas flue are opened and functional.
- DO NOT attempt to install, repair, or service the Water Heater by yourself.
Contact a qualified technician if the Water Heater needs repair or maintenance.
Ask your gas supplier for a list of qualified service providers.
- “Verify proper operation after servicing operation”
- The gas ignition system components must be protected from water (dripping, spraying, rain, etc.) during appliance operation and service (circulator replacement, condensate trap, control replacement, etc.)

⚠ DANGER

Do not operate the water heater if its combustion air intake is located in or near one of the areas or in the vicinity of products listed in Table. These areas will always contain hazardous contaminants that can form strong acids while passing through the burner and vent system. These acids will corrode the water heater’s heat exchanger, burner components and vent system, resulting in flue gas spillage and/or water leakage, possible substantial property damage, severe personal injury, or death. If the water heater combustion air intake is located in any area likely to cause or contain contamination, or if products which would contaminate the air cannot be removed, the intake must be re-piped and terminated to another location.

PRODUCTS TO AVOID	AREAS LIKELY TO HAVE CONTAMINANTS
Spray cans containing fluorocarbons	Dry cleaning/laundry areas and establishments
Permanent wave solutions	Swimming pools
Chlorinated waxes/cleaners	Metal fabrication plants
Chlorine-based swimming pool chemicals	Beauty shops
Calcium chloride used for thawing	Refrigeration repair shops
Sodium chloride used for water softening	Photo processing plants
Refrigerant leaks	Auto body shops
Paint or varnish removers	Plastic manufacturing plants
Hydrochloric or Muriatic acid	Furniture refinishing areas and establishments
Cements and glues	New building construction
Antistatic fabric softeners used in clothes dryers	Remodeling areas
Chlorine-type bleaches, laundry detergents, and cleaning solvents	Garages and workshops

Before Operation

CAUTION

■ **Check the gas being used.**

When the Water Heater is used or moved for the first time, user must check the type of gas being supplied matches the specific gas type for the appliance.

The type of gas is indicated on the rating plate on side of the water heater.

■ **Check the electricity being supplied.**

Please check the appliance is connected properly.

■ **Check the gas valve.**

Please confirm the gas valve connected to the water heater.

(it must be closed during installation)



■ **Check the water supply valve.**

Please leave the appliance water supply valve open at all times.(it must be closed during installation)

WARNING

■ **Do not store flammable material in the appliance room.**

Do not store portable gas container, thinner, oil, or other flammable materials in the room. Otherwise, fire may break out.

■ **Do not place combustible items, such as newspapers or laundry, near the appliance or venting pipe.**

Do not store combustible (flammable) materials such as papers. Do not hang clothes on the exhaust vent. Otherwise, fire may break out.

■ **Pull out the power plug from the receptacle if lightning strikes.**

Lightning can damage the water heater. Pull out power cord plug if lightning strikes for your safety.

■ **Burn Protection**

Be cautious when opening the hot water tap. The water may be very hot. Especially, children, disable and elderly are at the highest risk of being scalded. (Freeze protection is unavailable if the unit is unplugged from power.)

When in Operation

DANGER

■ **After repair of gas pipeline or gas regulator replacement, call service agent for inspection before starting it up.**

■ **Ventilation during gas leakage**

If exhaust gas enters room, it could cause poisoning by carbon monoxide. Check if the exhaust pipe is connected properly. Open windows for ventilation at appropriate intervals.

■ **What to do if you smell gas**

1. Do not try to light any appliance.
2. Do not touch any electrical switch; do not use any phone in your building.
3. Immediately call your gas supplier from a neighbor's phone. Follow the gas supplier's instructions.
4. If you cannot reach your gas supplier, call the fire department.



■ **Gas leakage test**

Gas supply line must be inspected regularly. (If air bubbles appear in soap water test, the gas is leaking out. Close the gas supply valve and call your gas supplier for inspection)

■ **In cases where the pipes are frozen**

Thaw the water supply pipeline or hot water discharge line with hair dryer or other electric heating device. If it does not work, Contact the installer or Service agent for assistance.

CAUTION

Do not shut off the Water Heater.

When you leave home for a long time, do not shut off the Water Heater. The Water Heater has a freeze protection function. The freeze protection feature will not work if electrical power, gas, or water is disconnected.

Do not wipe the appliance or control panel with wet cloth.

Otherwise, electric shock may occur, or internal parts may be deteriorated or failed due to the infiltration of moisture.

Do not disassemble the Water Heater.

Service must be performed by a qualified installer, service agency or gas supplier. Otherwise, Warranty will be voided.

Burn Protection

Do not touch the exhaust vent or hot water line during operation since they are very hot. Otherwise, the user may get burned.

Important Safety Information

 CAUTION

Do not drink water that has been inside the unit for an extended period of time. Do not drink the first use of hot water from the unit in the morning.

Clean the filter on the water inlet as frequently as required by the quality of your local water.

Keep the area around the unit clean.
If boxes, weeds, cobwebs, cockroaches etc. are in the vicinity of the unit, damage or fire can result.

Do not install the equipment where the exhaust will blow on walls or windows.

Problems resulting from scale formation are not covered by the warranty.

Check ignition during use and extinction after use.

Do not run water through the unit when unit is not on. When discharging hot water, make sure the unit is ON. If water is run through the unit with the unit OFF, water may condense inside the unit and cause incomplete combustion or damage to the internal electrical components.

Preventing damage from freezing. Damage can occur from frozen water within the device and pipes even in warm environments. Be sure to read below for appropriate measures. Repairs for damage caused by freezing are not covered by the warranty.

Take necessary measures to prevent freezing of water and leakage of gas when leaving the unit unused for long periods of time.

If it is snowing, check the intake and exhaust vent terminal for blockage.

Do not use parts other than those specified for this equipment.

Initial Operation

• Before the first use of your water heater, make the following preparations.

1. Open the water pipe valve.

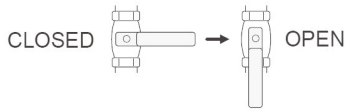

2. Open a hot water fixture/faucet to confirm that water is available, and then close the fixture/faucet again.

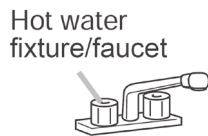

3. Open the gas supply valve.

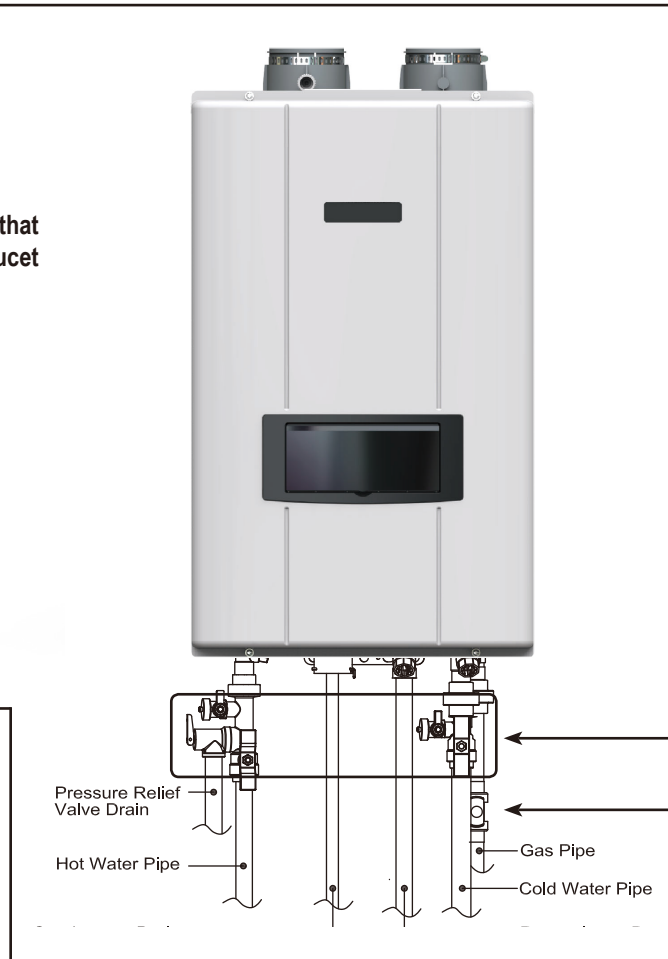
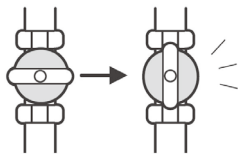

4. Turn on the power on the front panel.

Do not touch with wet hands.

Control Panel Interface

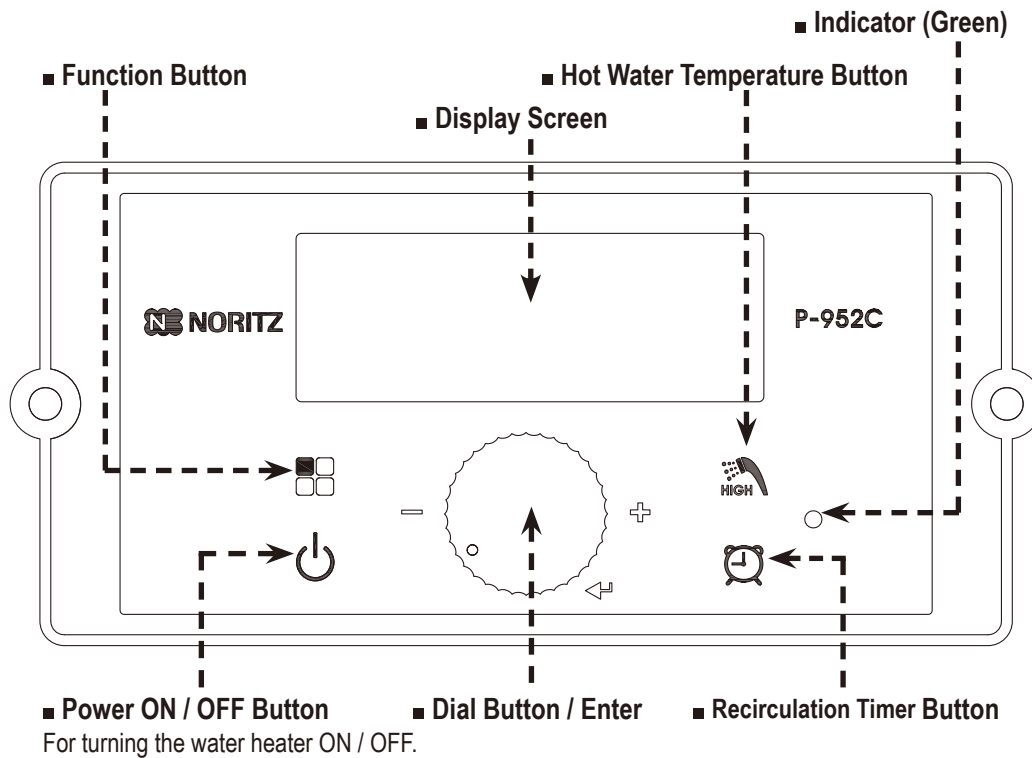

Buttons	Functionalities	
	Press (under 5 seconds)	Press and Hold (more than 5 seconds)
Power ON / OFF Button (🔌)	Control Panel Power ON/OFF	N/A
Function Button (🔲)	Cancel / Return	User Mode when power is ON Installer Mode when power is OFF
Hot Water Temperature Button (🌡️)	Hot Water Temperature Setting 100°F~120°F (38°C~49°C)	High Temperature Setting 125°F~140°F (51.5°C~60°C)
Recirculation Timer Button (🕒)	Recirculation Timer Setting	N/A
Dial Button (⌚)	Press : Enter Rotate : UP(+)/ DOWN(-)	N/A

Control Panel LCD Interface

- LCD has a backlight that will illuminate:
- When a user action is detected (a button is pressed)
 - Turns off when no action within approximately 20 seconds.

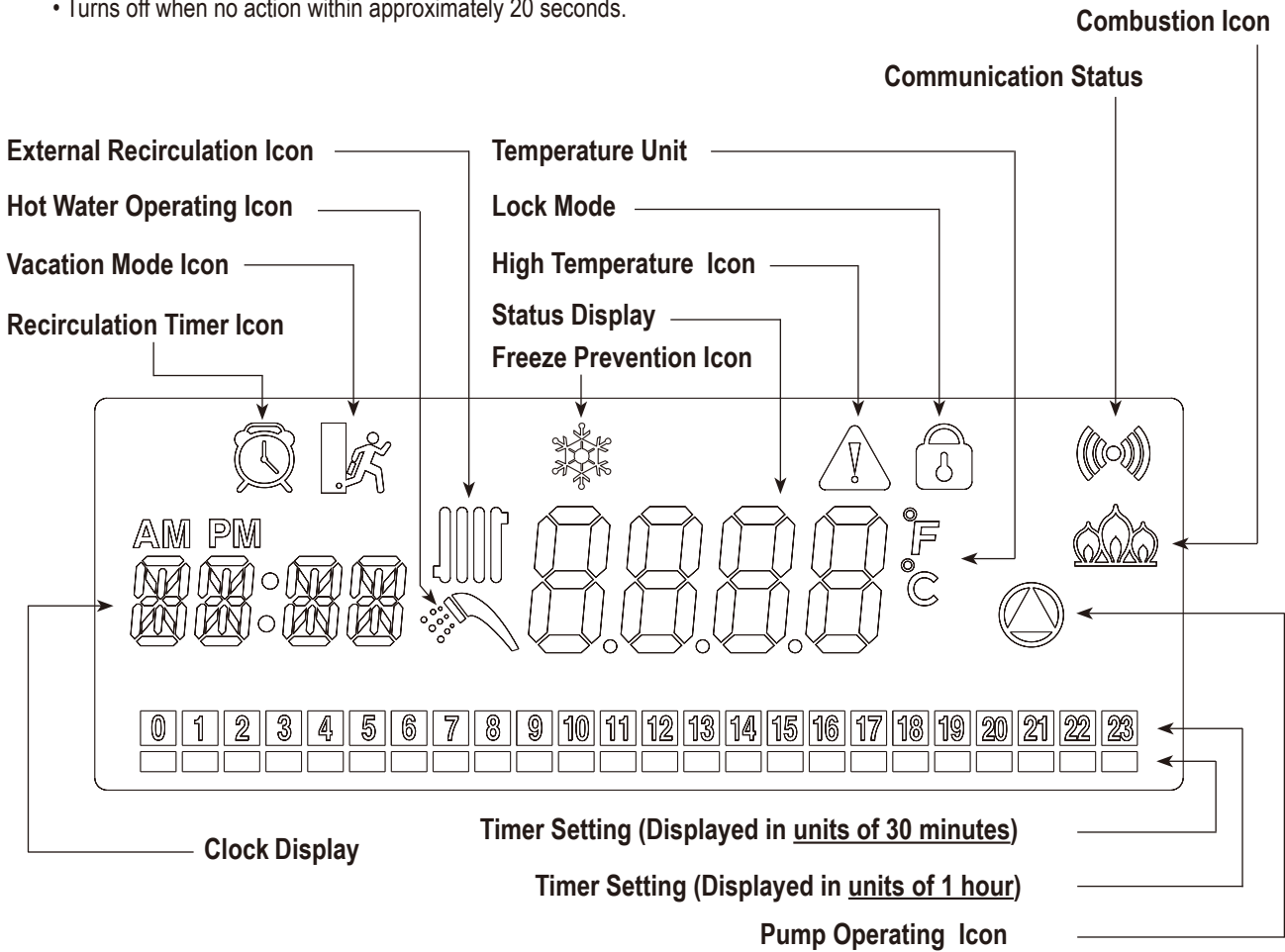

[Example]

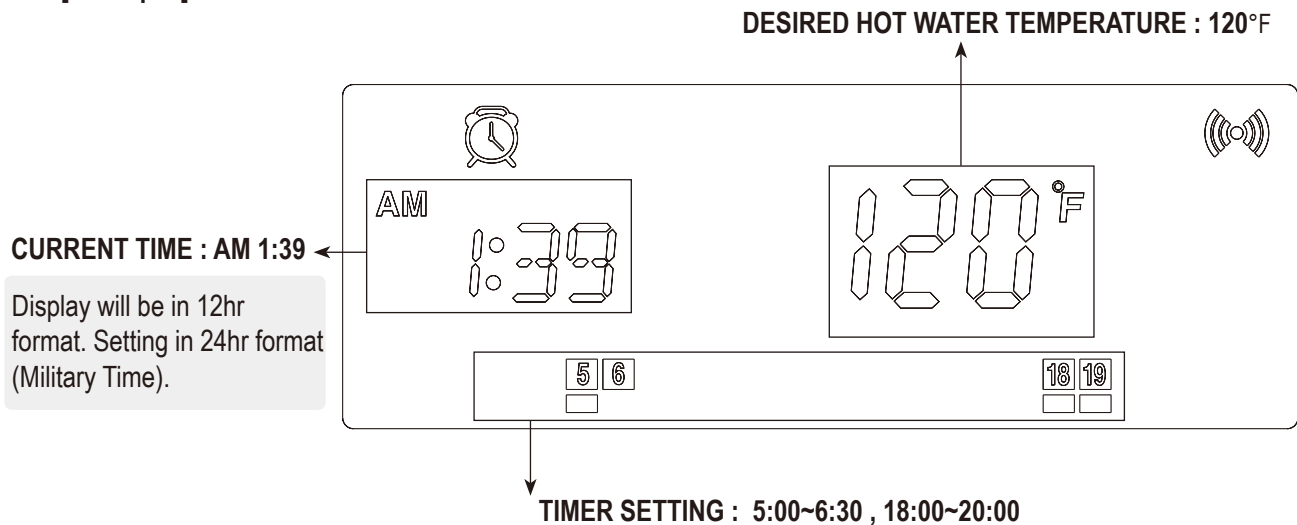

1. Clock Adjustment

- ▶ To use the 'Recirculation Timer Mode', the device's internal clock should be adjusted to the current time. Clock settings can be set in the 'User Mode'.

[To enter 'User Mode']

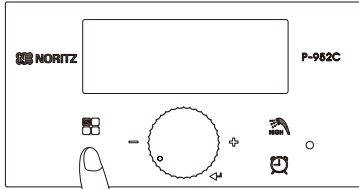

Power on the control panel must be on.

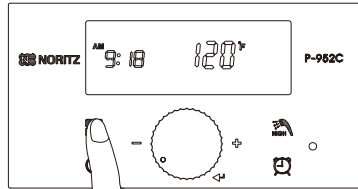

Press and hold 'Function Button' for approximately 5 seconds to enter 'User Mode'.

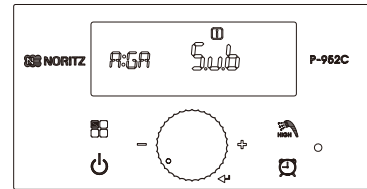

'[A:GA]' is displayed on the display screen. From here, turn the 'Dial Button' to start the setting.

Clock Adjustment

- Set in [M:TA] after turning the 'Dial Button' in 'User Mode'.
- Set the HOUR - MINUTE in regular sequence..

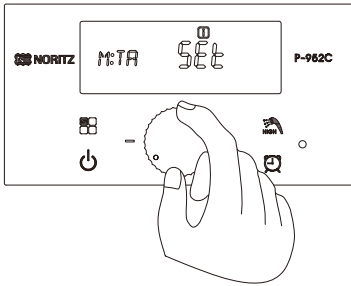

Turn the 'Dial Button' clockwise until [M:TA] is displayed.

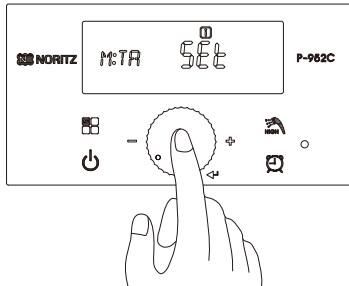

Enter the Clock 'Setting mode' by pressing 'Dial Button' when flashing the [M:TA].

Customer can set the current time in [M:TA].

1. Setting hour : 14
(Setting in Military Time)

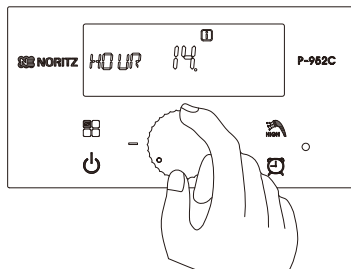

Set the 'hour' by turning the 'Dial Button'.
(Only the flashing number can be changed.)

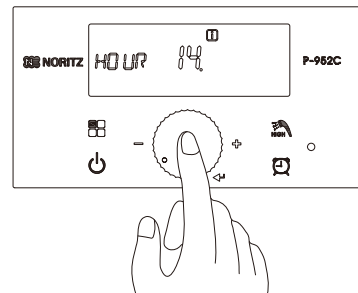

Press the 'Dial Button' to store the setting.

2. Setting minute : 10

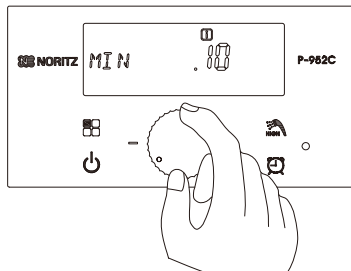

Set the 'minute' by turning the 'Dial Button'.
(Only the flashing number can be changed.)

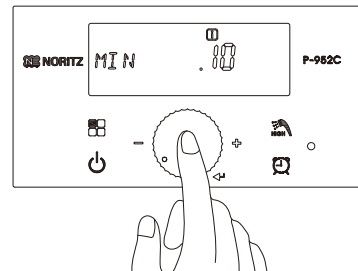

Press the 'Dial Button' to store the setting.

3. Press 'Function Button ()' to return to normal operation mode.

2. Setting Hot Water Temperature

The operation of the high temperature hot water can be set separately.

	General temperature range					High temperature range				
°F	100	105	110	115	120	125	130	135	140	
	Default									
°C	38	40.5	43.5	46	49	51.5	54.5	57	60	

The temperature settings below are examples. The temperature setting necessary depends on the usage, the length of piping and the time of year.

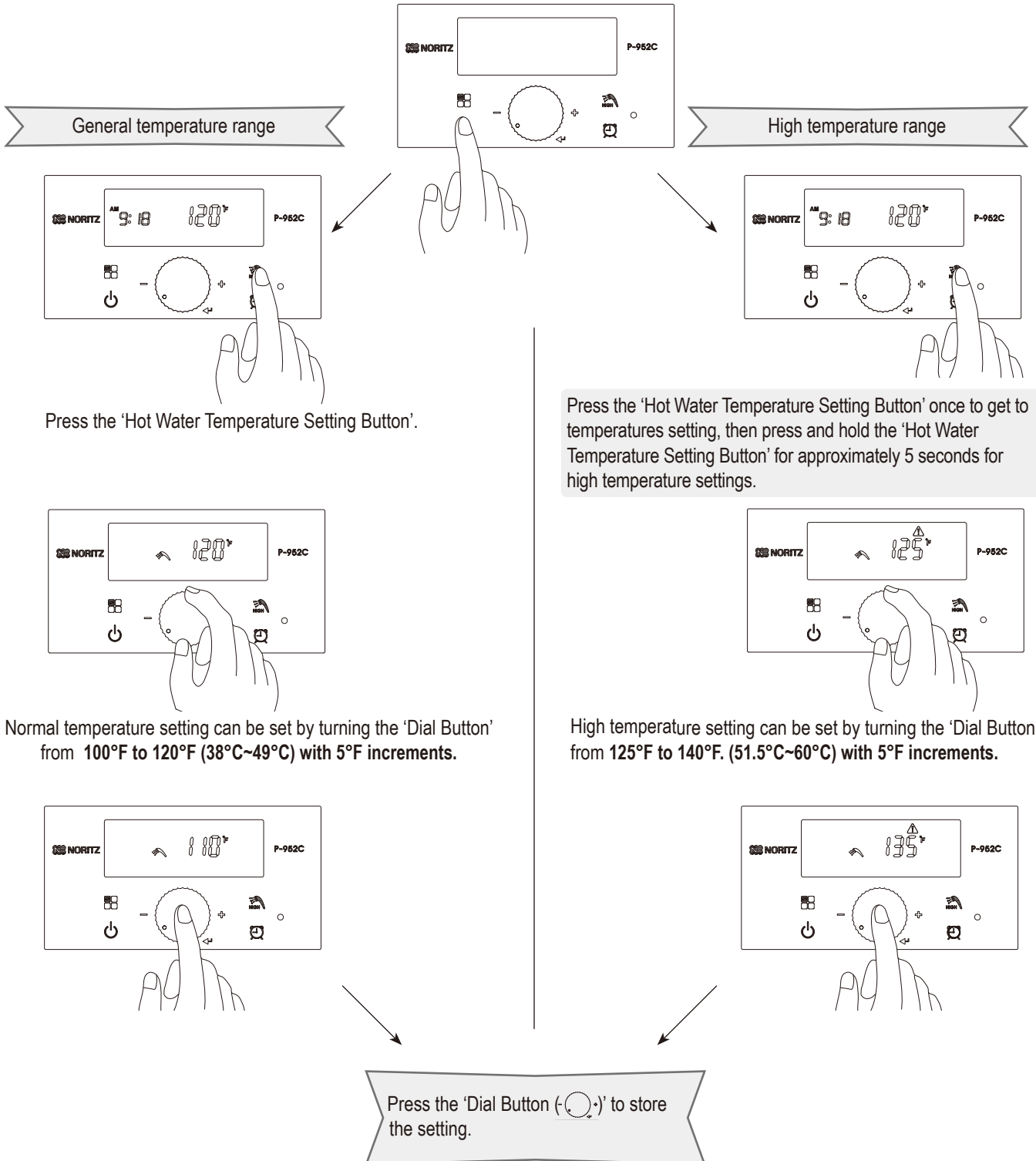

‘User Mode’ confirmation function

Function can be checked and set in ‘User Mode’.
 ([C: TL] - [I: EH] - [K: RH] - [L: FC] - [M:TA])

Screen Display	Operation	Description
C: TL	Temperature Lock Mode	Lock mode is used(On) or unused(oFF)
I: EH	Error History	View the Error History (E0:XX ~ E9:XX)
K: RH	Running History	PLUG / bnHr / igCY / PPHr
L: FC	Gallon or Liter Unit	GAL / Lit
M:TA	Clock Adjustment	Set current time

[To enter ‘User Mode’]

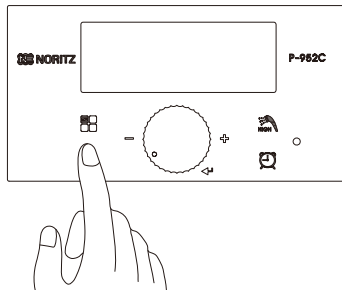

1. Press the ‘Power Button’ ON.

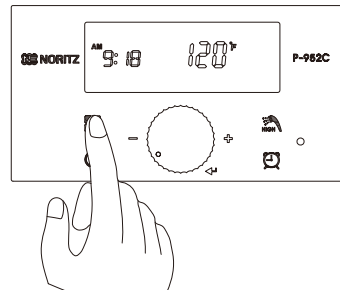

2. Press and hold ‘Function’ Button for approximately 5 seconds to enter ‘User Mode’.

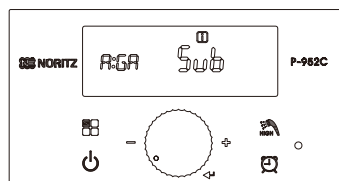

3. [A:GA] is displayed on the Display screen. From here, turn the ‘Dial Button’ to start the setting.

3. Locking the Control Panel. [C:TL]

By locking the control panel, the settings cannot be accidentally changed if a button is pressed by mistake.

- Refer to page 13 'User Mode' setting method and set to 'User Mode'.
- Function can be checked by turning the dial button.

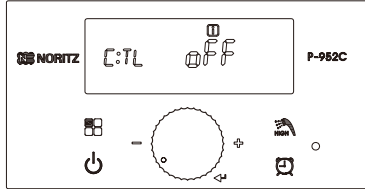

1. Select the [C:TL] by turning the 'Dial Button' in 'User Mode'.

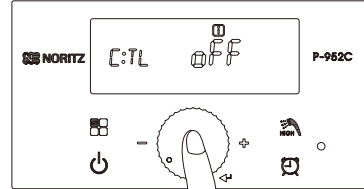

2. 'Lock Mode' is started and 'off' is flashing when the 'Dial Button' pressed in [C:TL].

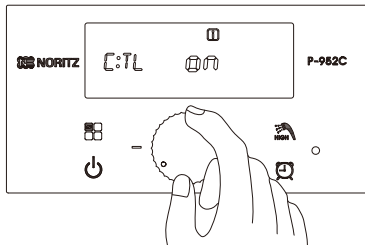

3. Select the 'on' by turning the 'Dial Button' clockwise.

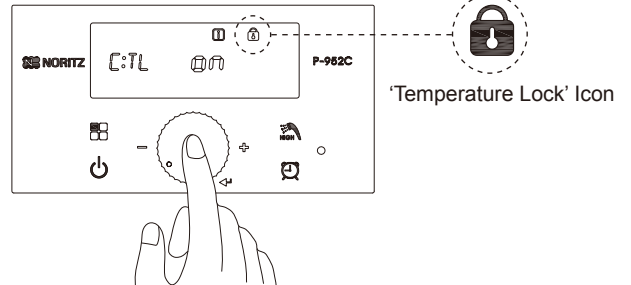

4. Press the 'Dial Button' to store, lock icon is displayed. And return to 'User Mode'

4. How to check the 'Error History'. [I:EH]

- Refer to page 13 'User Mode' setting method and set to 'User Mode'.
- Function can be checked by turning the dial button.

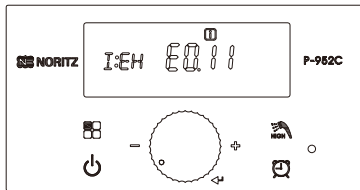

1. Select the [I:EH] by turning the 'Dial Button' in 'User Mode'.

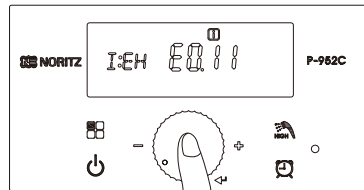

2. Error codes that have occurred can be identified and (ex) 'E0.11' is flashing when the 'Dial Button' is pressed in [I:EH].

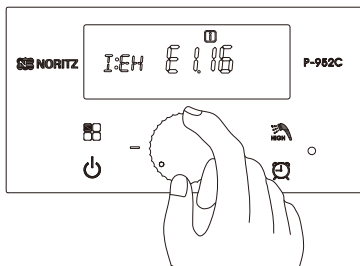

3. Error codes that have occurred from E0 to E9 can be identified by turning the 'Dial Button' clockwise.

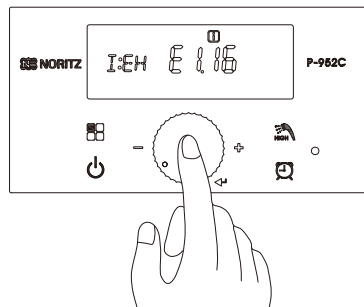

4. Pressed the 'Dial Button' to return to 'User Mode'

[For example]
1st error occurs : 11 , 2nd error occurs: 16

5. How to check the 'Running History'. [K:RH]

- Refer to page 13 'User Mode' setting method and set to 'User Mode'.
- Function can be checked by turning the 'Dial Button'.

Screen Display	Operation	Description
PLUG	Plug in Time	EX) 102.8 → 102.8 X 1000 = 102,800 hour
bnHR	Burn Hour	EX) 31.07 → 31.07 X 1000 = 31,070 hour
bnCY	Burn Cycle	EX) 4307 → 4307 X 1000 = 4,307,000 times
PPHr	Pump Running Time	EX) 347.1 → 347.1 X 1000 = 347,100 hour

[PLUG] : Means the time of the power supply.
EX) 102.8 → 102.8 X 1000 = 102,800 hour

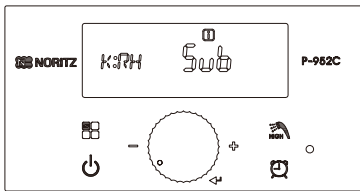

1. Select the [K:RH] by turning the 'Dial Button' in 'User Mode'.

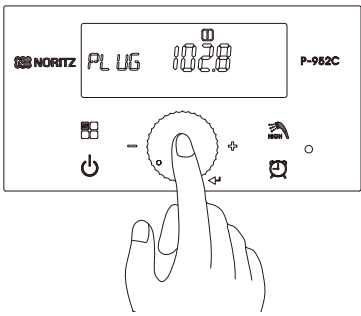

2. If 'Dial Button' is pressed in [K:RH], [K:RH] is changed to [PLUG].

[bnHr] : Means burn hour.
EX) 31.07 → 31.07 X 1000 = 31,070 hour

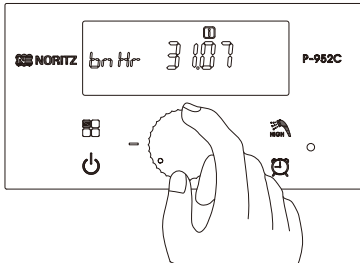

3. Turn the 'Dial Button' clockwise to be changed to [bnHr].

[bnCY] : Means burn cycle.
EX) 4307 → 4307 X 1000 = 4,307,000 times

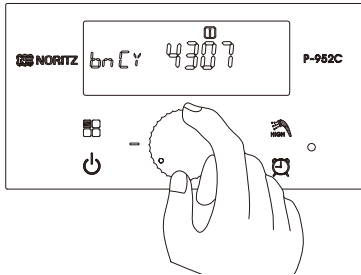

4. Turn the 'Dial Button' clockwise to be changed to [bnCY].

[PPHr] : Means the time of the PUMP operating
EX) 347.1 → 347.1 X 1000 = 347,100 hour

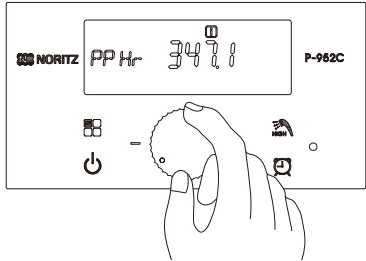

5. Turn the 'Dial Button' clockwise to be changed to [PPHr].

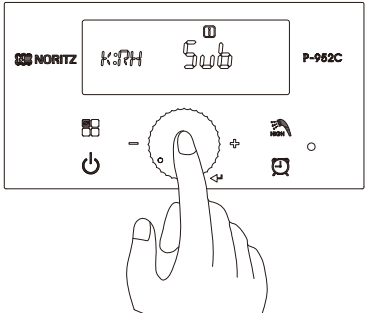

6. Press the 'Dial Button' to return to 'User Mode'.

6. Setting the 'Unit'. [L:FC]

- Refer to page 13 'User Mode' setting method and set to 'User Mode'.
- Function can be checked by turning the 'Dial Button'.

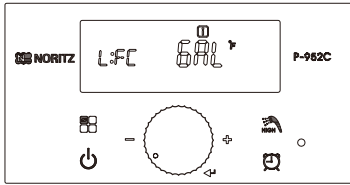

1. Select the [L:FC] by turning the 'Dial Button' in 'User Mode'.

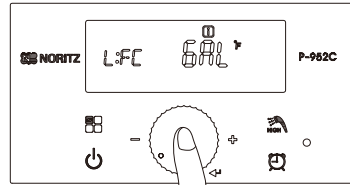

2. If 'Dial Button' is pressed in [L:FC], 'GAL' is flashing. (If flashing is 'GAL', units displayed on the display screen are GPM and Fahrenheit.)

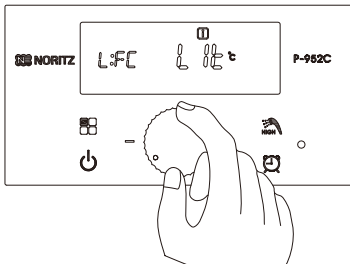

3. Turn the 'Dial Button' counter-clockwise to 'Lit', the units displayed on the display screen are LPM and Celsius.

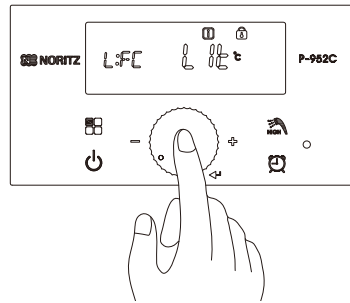

4. Units currently displayed on the display screen are determined when you press 'Dial Button'. And return to 'User Mode'.

Screen Display	Operation	Description
	Unit : Gallon & Fahrenheit	All of the units displayed on the display screen are GPM & °F
	Unit : Liter & Celsius	All of the units displayed on the display screen are LPM & °C

7. Programming to use the Recirculation System

Note :

[1:RC] mode function must be 'on' in **'Installer Mode'** in order to use the 'Recirculation Timer'. ('Recirculation Timer' function is only enabled in 'Recirculation Mode'.)

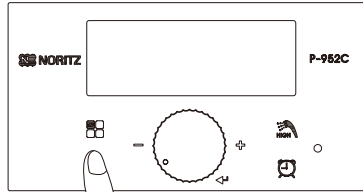

To enter 'Installer Mode' press the 'Power Button' on the display the screen will be blank. Press the 'Function Button' for approximately 5 seconds.

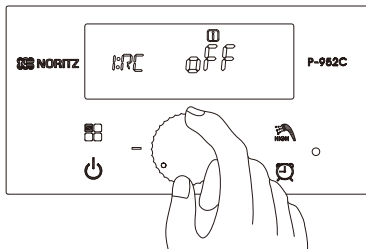

1. Turn the 'Dial Button' to [1:RC].

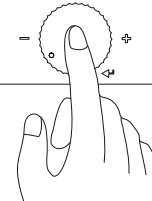
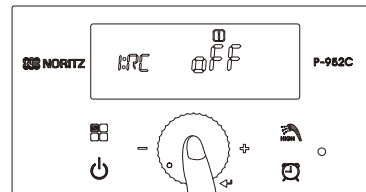

2. 'oFF' is flashing when the 'Dial Button' is pressed in [1:RC]. (Default setting is 'oFF' and recirculation function is turned off.)

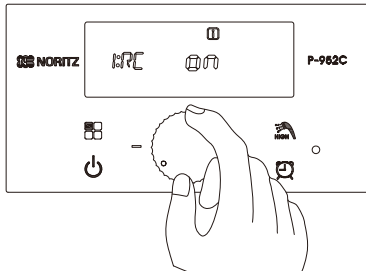

3. Select the 'on' by turning the 'Dial Button' clockwise in order to activate the recirculation function.

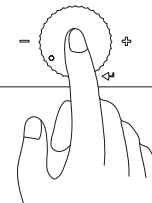
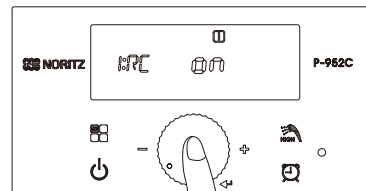

4. Press the 'Dial Button' to store the current setting, and return to 'Installer Mode'.

5. Press 'Function Button' to exit 'Installer Mode'.

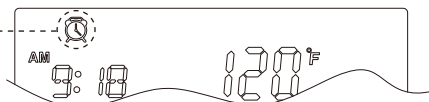

Activation of the 'Recirculation Timer' icon on the main screen indicates feature activation.

Default times are AM 5~8 and PM 5~11 for recirculation timer mode. Customer who accept the default times do not need to do 'Recirculation Timer' setting in the following section.

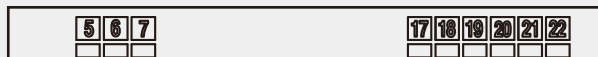

7. Programming to use the Recirculation System

► **Table for ‘Recirculation Timer’ setting.**

‘Recirculation Timer’ function has three settings ([Act], [SEt], [cLr]). [Act] is to activate the ‘Recirculation Timer’, [SEt] is to customize the times appropriate to the end user and [cLr] is to reset to factory default the setting.

To activate the ‘Recirculation Timer’ Type.		
Act	Prog	Program mode. Select the custom program from recirculation timer mode. Must be set in ‘SEt’ first. (See below for details)
	Auto	Auto mode. Unit memorizes the user’s hot water usage patterns. (Self learning mode) Uses info to generate setting. Refer to the page 19 for details.

To set the ‘Recirculation Timer’.		
SEt	Prog	Customized end user’s desired recirculation times. Refer to the page 19~21 for details.

To clear ‘Recirculation Timer’.																					
cLr	Prog	Reset to factory default. (5 to 8 AM, 5 to 11 PM) Refer to the page 22 for details.																			
	Auto	<table border="1" style="margin: auto;"> <tr> <td style="text-align: center;">5</td> <td style="text-align: center;">6</td> <td style="text-align: center;">7</td> <td style="width: 100px;"></td> <td style="text-align: center;">17</td> <td style="text-align: center;">18</td> <td style="text-align: center;">19</td> <td style="text-align: center;">20</td> <td style="text-align: center;">21</td> <td style="text-align: center;">22</td> </tr> <tr> <td style="text-align: center;">□</td> <td style="text-align: center;">□</td> <td style="text-align: center;">□</td> <td></td> <td style="text-align: center;">□</td> <td style="text-align: center;">□</td> <td style="text-align: center;">□</td> <td style="text-align: center;">□</td> <td style="text-align: center;">□</td> <td style="text-align: center;">□</td> </tr> </table>	5	6	7		17	18	19	20	21	22	□	□	□		□	□	□	□	□
5	6	7		17	18	19	20	21	22												
□	□	□		□	□	□	□	□	□												

7. Setting the ‘Recirculation Timer’. (Selecting Timer Type ‘Auto’ / ‘Prog’)

7-1 Set the ‘Recirculation Timer Type’ to ‘Auto’.

[Auto Function] :

If flame is detected by customer usage, that time is stored. The following day, the water pattern from the previous day is used to control the pre-heat and provide prompt hot water.

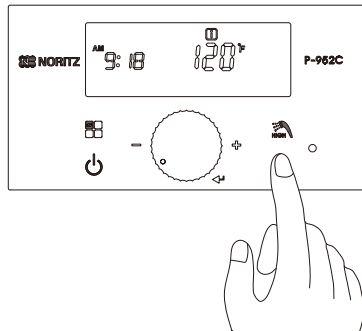

1. Press the ‘Recirculation Timer Button’ when power of the display screen is turned on.

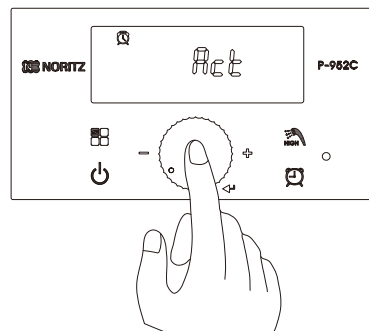

2. ‘Recirculation Timer Icon’ and [Act] are flashing on display screen. Press the ‘Dial Button’ to activate the ‘Recirculation Timer’ function.

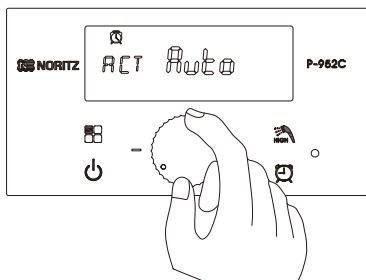

3. Select the [Auto] by turning the ‘Dial Button’ counterclockwise to set the auto mode. Then press the ‘Dial Button’ to set.

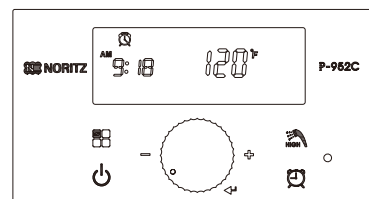

4. Recirculation function is operated from next day after automatically recognizing the user’s patterns when auto recirculation function is selected.

7. Setting the 'Recirculation Timer'. (Recirculation_Program Mode)

7-2 Set the 'Recirculation Timer' in 'Prog' mode.

- Customer can directly set the time in 'Recirculation Mode'.

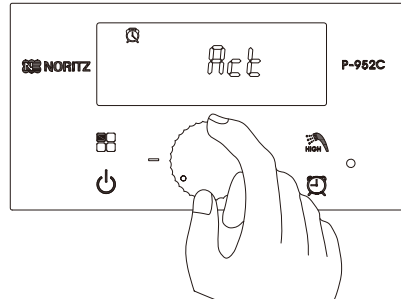
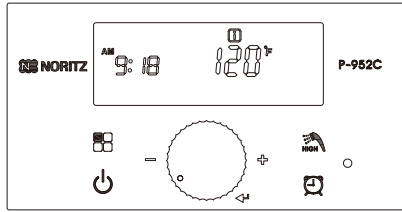

1. Press the 'Recirculation Timer Button' while power of the display screen is turned on.

2. If [Act] is flashing, select the [SEt] by turning the 'Dial Button'.

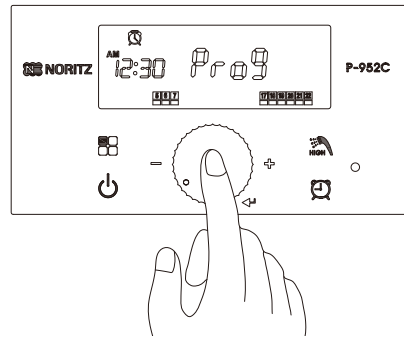
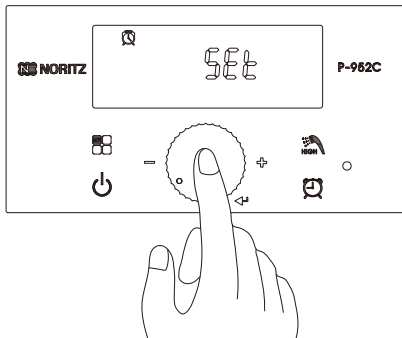

3. Press the 'Dial Button' to enter the 'Setting Mode'.

4. Press the 'Dial Button' to set the desired time zone. (The default time zone are saved and can be changed to the desired time zone.)

Time is displayed from 12:00. Turn the 'Dial Button' clockwise, time on the display screen is changed in increments of 30 minutes. To set the desired time zone, move to the start time of the desired time zone, press the 'Dial Button' to set it, turn the 'Dial Button' to the desired end time, and press 'Dial Button' to save the time zone area.

Press the 'Dial Button' at the desired time zone, turn the 'Dial Button', and press the 'Dial Button' at the end of the desired time to complete the selection.

ex) Setting time : 1:00~2:30

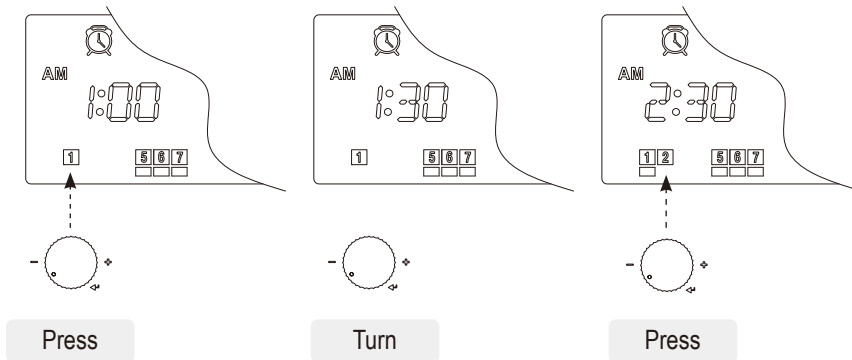

ex) Setting time : am 1:00 ~ 2:30 , AM 11:00~PM 2:30 (default time : AM 5:00~8:00, PM 5:00~11:00)

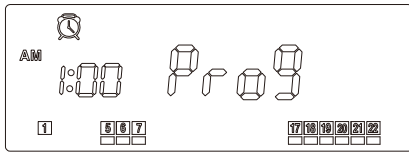

5. Press the 'Dial Button' after locating the desired start time. (AM 1:00 ~)

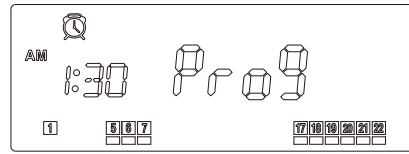
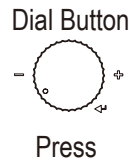

6. When you press the 'Dial Button', the clock time increases by 30 minutes. Turn the 'Dial Button' to ending time. (~ AM 2:30)

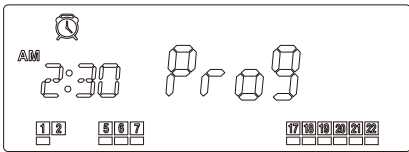
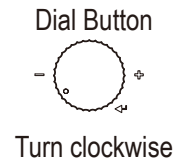

7. Press the 'Dial Button' after locating the 'Dial Button' by desired time. (AM 1:00 ~ 2:30)

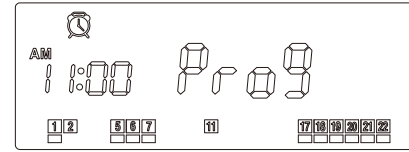

8. Press the 'Dial Button' after locating the desired start time.(AM 11:00 ~)

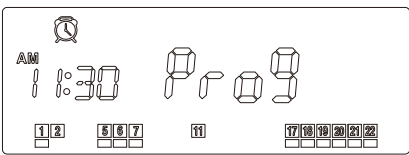
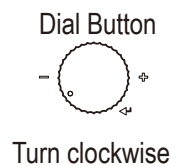

9. When you press the 'Dial Button', the clock time increases by 30 minutes. Turn the 'Dial Button' to ending time. (~ PM 2:00)

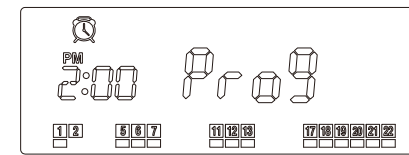
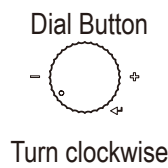

10. Press the 'Dial Button' after locating the 'Dial Button' by desired time. (AM 11:00 ~ PM 2:00)

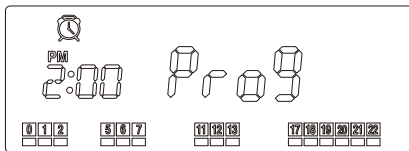
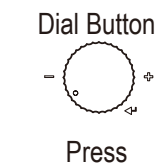

11. If you no longer need to set the time, press and hold the 'Dial Button' for approximately 2 seconds to store.

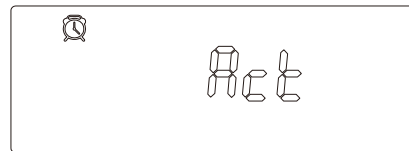
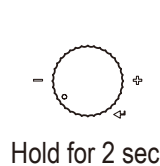

12. If all of settings are stored, 'Act' will be flashing. Press the 'Dial Button'.

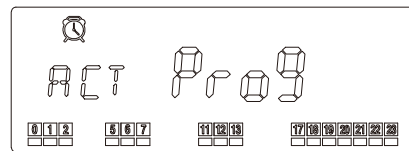
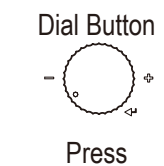

13. Saved program from step 11 will flash on screen. If correct, press the 'Dial Button' to complete programming.

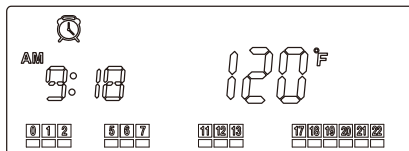

14. Programming done.

[TIP for the 'Recirculation Timer']

- Press the 'Dial Button' (less than 1 second) : Selecting a start time and an end time
- Turn the 'Dial Button' : Selecting a number of times
- Press and hold the 'Dial Button' (more than 2 seconds) : Save new timer setting

If you want to delete the selected time zone, move to the time zone you want to delete and press the 'Dial Button'.

7. Setting the 'Recirculation Timer'. (Recirculation Initialization)

7-3 Recirculation function initialization setting

- Reserved contents can be initialized.

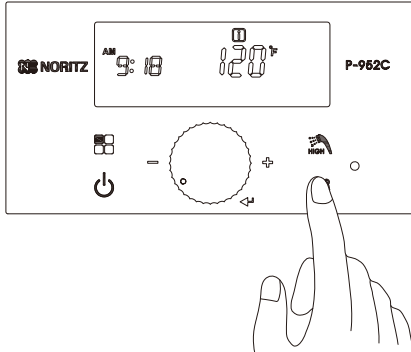

1. Press the 'Recirculation Timer Button' when display screen is turned on.

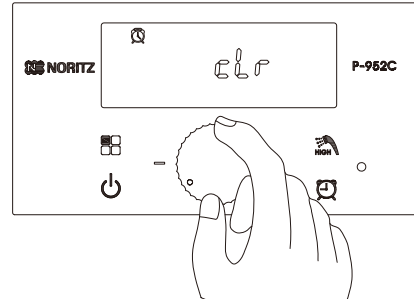

2. [Act] is flashing on display screen. Turn the 'Dial Button' clockwise to select the [cLr].

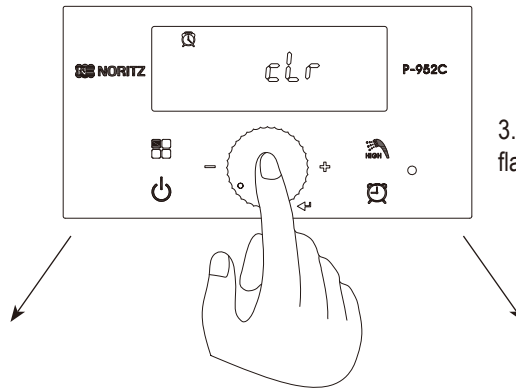

3. Press the 'Dial Button' when [cLr] is flashing on display screen.

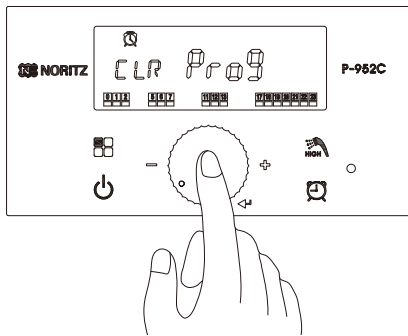

4A-1 Press the 'Dial Button' to initialize the program recirculation setting when the [Prog] is flashing on the display screen.
All recirculation timers get deleted except default timer.

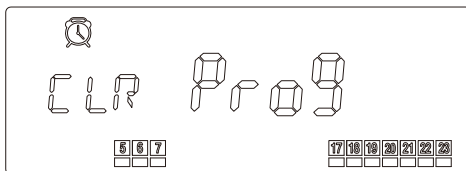

4A-2 Press the 'Recirculation Timer Button' to return to the previous step after setting completion.

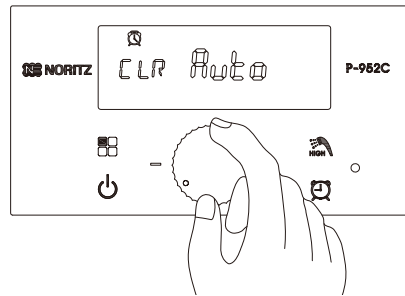

4B-1 Press the 'Dial Button' to initialize the program recirculation setting when the [Auto] is flashing on the display screen.
All recirculation timers get deleted except default timer.
4B-2 Press the 'Recirculation Timer Button' to return to the previous step after setting completion.

Vacation Mode

If no hot water is used for more than 30 hours, the recirculation program will be stopped and display  icon. Vacation Mode will stop when hot water is used.

8. Setting the ‘Recirculation System’.

Mode	Description	Setting		Requirement		Performance		
		1:RC	2:RM	Dedicated Return Line	Accessory	Wait Time Water Savings	Energy Savings	Hot Water Temperature
No Recirculation - page 23	Same as regular tankless water heaters.	OFF	NA	NO	-	-	-	-
External* [Etnl] - page 23	Quick hot water with dedicated return line.	ON	Etnl	YES	-	Best	Good	Best
On-Demand* [tt24] - page 24	Only operates recirculation line with a push of a button.	ON	tt24	YES	IHK-NRCP	Better	Best	Hot
Crossover* [CrOS] - page 24	Quick warm water without dedicated return line.	ON	CrOS	NO	COV-1	Best	Better	Warm

* Recirculation is activated by Timer [Auto / Manual].

Recirculation timer setting can be changed to meet customer's desired schedule.
Auto (self learning mode) function can be selected by customer's need.

You can choose from three pre-heating modes:

To select a recirculation mode, you must set from the ‘Installer Mode’ on the front control panel.(Refer to the page 25)
When you use a recirculation mode, there will be some minor efficiency loss, as a result of the water heater maintaining a steady temperature within the recirculation loop.
With the recirculation operation, hot water will be automatically circulated in the hot water pipes. Even with this function activated, it may take several minutes for hot water to be completely circulated through the plumbing system. Set the timer to activate the recirculation system prior to the first use of hot water to ensure hot water is available.

Recirculation Mode

The recirculation pipe must be installed in the field in order to apply the ‘Recirculation Mode’.
This mode allows the water heater recirculation pipes to be warmed up and serving as the freeze protection function.

[External Mode]

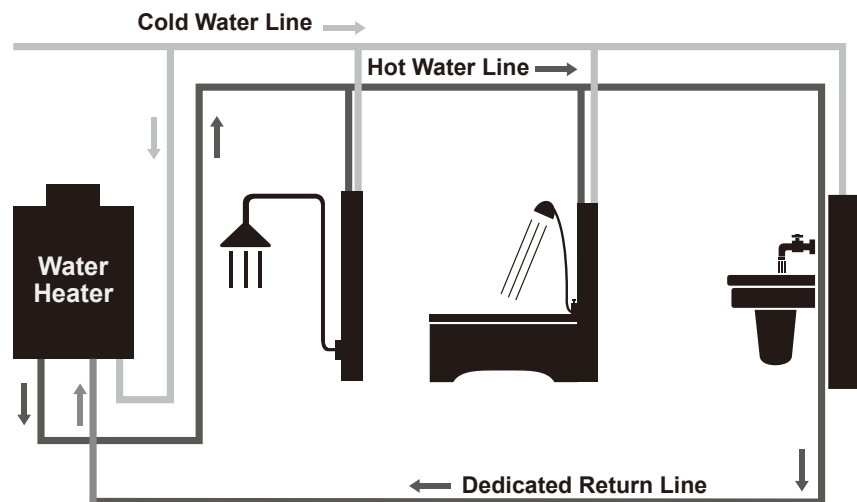

Recirculation Mode

When using recirculation mode with the built-in pump, check the following maximum recirculation pipe lengths including fittings (3/4" pipe is recommended):
 -1/2" Pipe- 200' (60m) of equivalent length
 -3/4" Pipe- 500' (150m) of equivalent length
 Lengths in excess of these limits will require an recirculation pump.

[On Demand(tt24) Mode]

* On Demand Mode designed to deliver hot water to your entire home with the press of a button (within a few minutes).

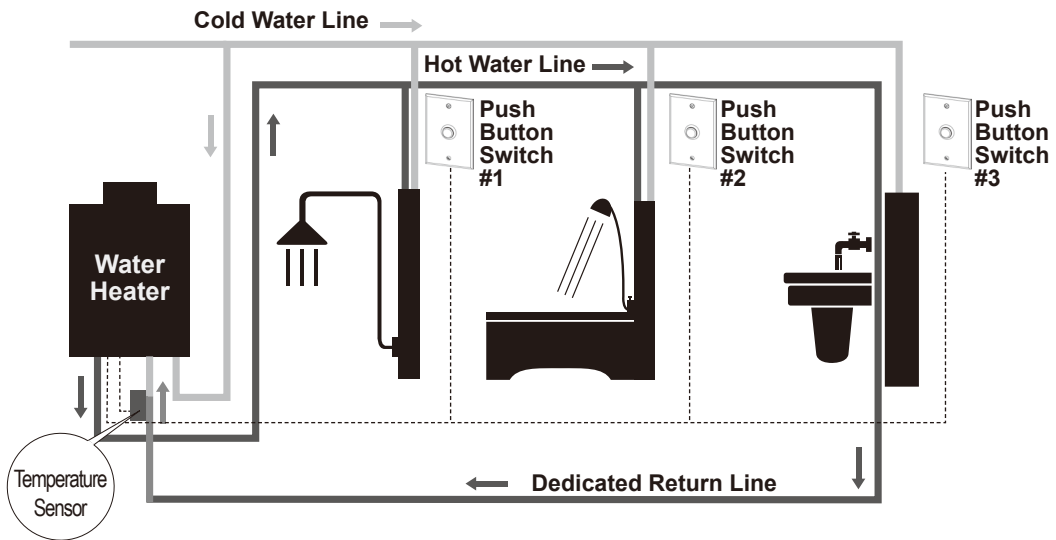

[Crossover(CrOS) Mode]

* Provides recirculation option for homes without a dedicated return line by utilizing the cold water line as a return line.

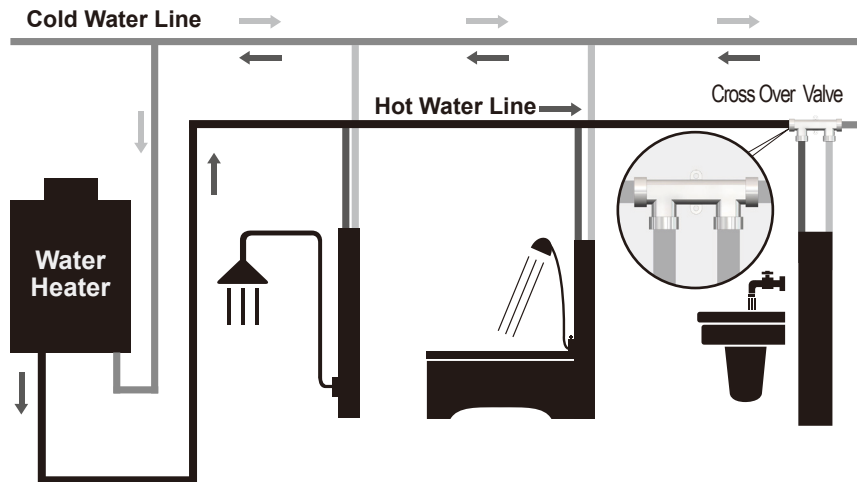

8. Setting the 'Recirculation System'.

8-1. To set the recirculation type (External, On-Demand, Crossover Mode)

1. Press the 'Power Button' OFF. ('Display Screen' will be blank)
Push and hold the 'Function Button' to enter Installer Mode.

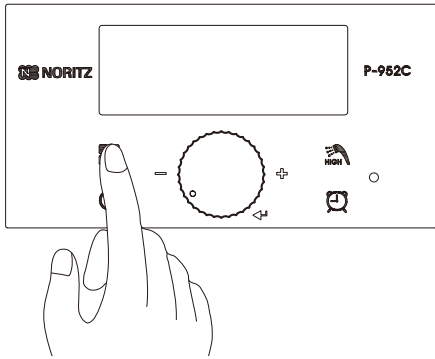

2. '1:RC' OFF will appear on the 'Display Screen'. ('1:RC' will be blinking) Press the 'Dial Button' and 'oFF' will start blinking.

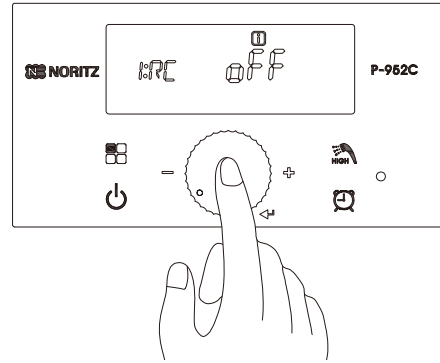

3. Turn the 'Dial Button' so 'on' is blinking.

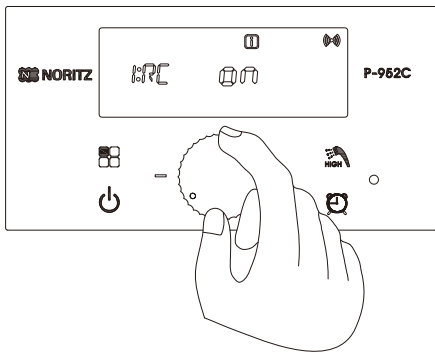

4. Press the 'Dial Button' to save the setting.

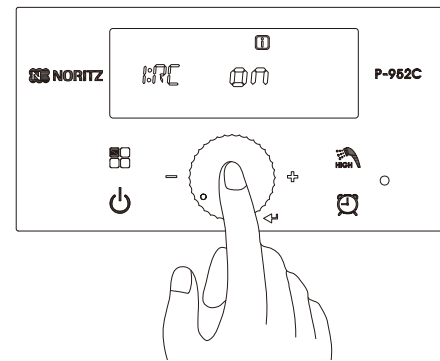

5. Turn the 'Dial Button' so '2:RM' is displayed.

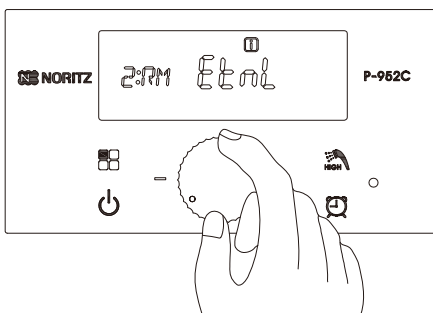

- ※ 'EtnL' is for External Mode.
- ※ 'tt24' is for Title-24(On Demand) Mode.
- ※ 'CrOS' is for Crossover Mode.

Verify which type of Recirculation System is installed. (See page 23.)

6. Push the 'Dial Button' so 'EtnL' or 'tt24' or 'CrOS' is blinking. Turn the 'Dial Button' to the correct mode.
7. Push the 'Dial Button' to save the setting.
8. Push the 'Function Button' to exit Installer Mode.
9. Push the 'Power Button' to turn the water heater back on.

[2:RM] function can be selected only after activating the [1:RC] function.

Screen Display	Operation	Description
EtnL	External Mode	[2:RM] Mode is operated during [1:RC] mode turned 'on'.
tt24	On-Demand Mode	
CrOS	Crossover Mode	

9. Preventing Damage from Freezing-1

CAUTION

- Damage can occur from freezing water within the device and pipes even in warm environments. Be sure to read below for appropriate measures.
- Repairs for damage caused by freezing are not covered by the warranty.

1. Two modes for freeze protection.

1-1. Recirculation Pump mode.

- When water temperature falls between 42°F(5.5°C) and 46°F(8°C), the circulation pump starts operating for freeze protection.
- Water mixing valve maintains open for internal water circulation.
- The cycle will restart at the approximate time interval (operate for 10 min and stops for 30 sec) and it will stop if the water temperature goes above 50°F(10°C).

1-2. Burner Combustion mode.

- When water temperature drops below 41°F (5°C) it will start minimum combustion with internal water circulation.
- When water temperature goes above 104°F (40°C) it will stop.
- After combustion mode is stopped, the pump will continue for 3 minutes.
- If the water heater is turned on for recirculation or domestic hot water use the freeze protection mode will automatically stop.

Electrical power, gas, water and the main switch must be on. If any of the above items are not connected properly, then water must be drained including the condensation trap and unit unplugged from electrical power.

2. It is possible to prevent freezing by selecting a 'Recirculation Mode'.

- With the recirculation operation set, hot water will be automatically circulated in the hot water pipes.
- If the recirculation piping is installed, you can select the external recirculation mode, the water heater will prevent the external plumbing to the unit from freezing.

- If there is still a risk that the unit will freeze, drain the unit as shown on page 30.

If water does not flow because it is frozen.

1. Close the gas and water valves.
2. Turn off the power button.
3. Open the water supply valve from time to time to check whether water is running.
4. When the water is flowing again, check for water leaks from the equipment and piping before using.

If the heater or the piping is frozen, do not use the heater or it may get damaged.

3. If the water heater will not be used for a long period of time, drain the water.

CAUTION

- To avoid burns, wait until the equipment cools down before draining the water.
- The appliance will remain hot for short period after it is turned off.

Drain water into a bucket to prevent water damage.

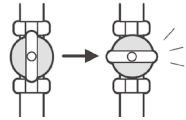
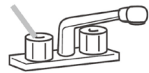
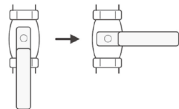
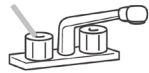
<p>1. Close the gas valve.</p>	
<p>2. (1) Turn the power on/off button "On". (2) Turn and leave open the hot water fixtures/ faucets for more than 2 minute and close. * If multiple units are being used, drain two minutes for each unit. * An 11 Error Code may appear on the control panel. This is not a malfunction of the unit. Do not turn Power ON/OFF Button OFF.</p>	<p>Hot water fixture/faucet</p> 
<p>3. Close the water supply valve and disconnect the electrical power supplied to the unit.</p> <p style="text-align: center;">Do not touch with wet hands.</p>	
<p>4. Fully open all hot water fixtures/faucets.</p>	<p>Hot water fixture/faucet</p> 
<p>5. Open all drain plugs and drain the water out of the unit. 6. When the water is completely drained, replace all drain plugs and close the hot water fixtures/faucets.V</p>	

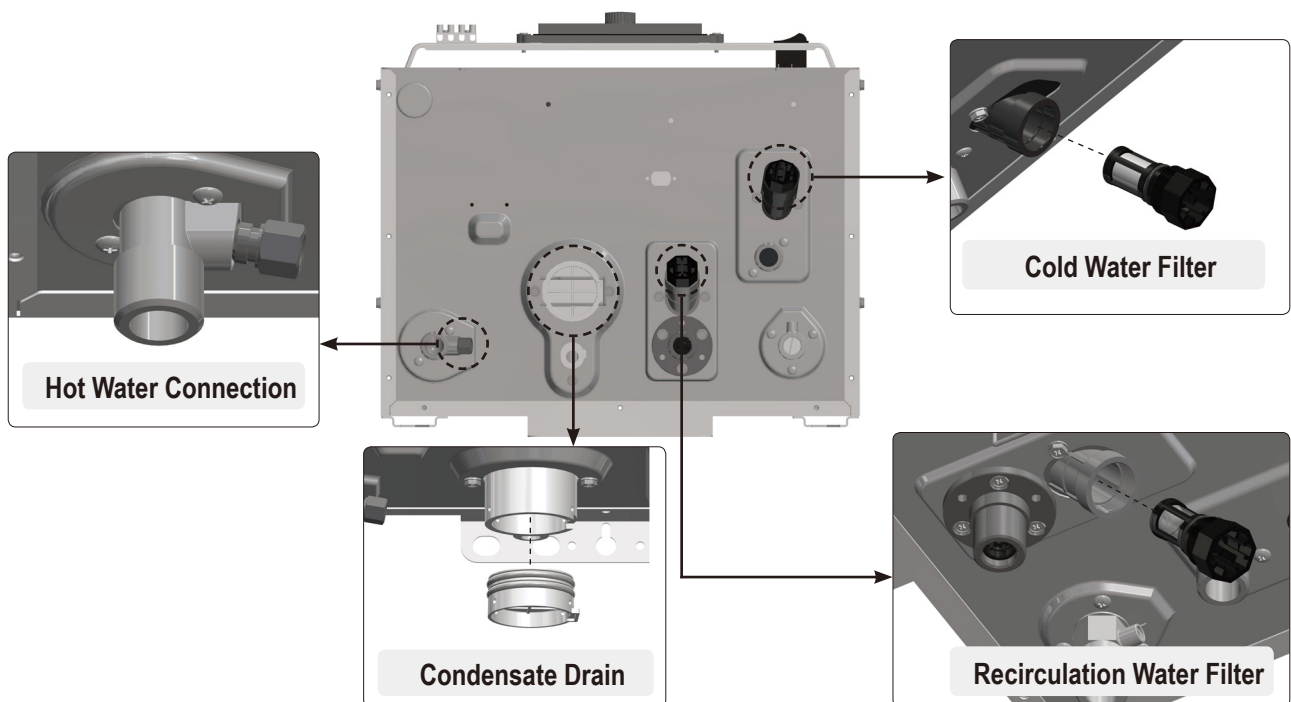

10. Preventing Damage from Freezing-2

1. Turning the Unit Back On

1. Check that all drain plugs are inserted.
 2. Check that all hot water fixtures/faucets are closed.
 3. Follow the procedure on page 8 'Initial Operation', steps 1 through 4.
 4. Make sure that the area around the appliance is well ventilated; open a window or a door if necessary.
Then, operate the unit and verify that condensate is coming out of the drain pipe.
(During normal use of the water heater, condensate will begin to discharge from the drain pipe within 15 minutes of use. However, depending on the season and/or installation site conditions, it may take longer.)
- If water does not appear at the end of the drain line, a qualified service technician must clean the condensate line.

DANGER

After the water heater has been out of use for a long time make sure that you fill the condensate trap with water.

This is to prevent dangerous exhaust gases from entering the building.

Failure to fill the condensate trap could result in severe personal injury or death.

(By performing step 4 as described above, the condensate trap will automatically fill itself with water.)

1. General Maintenance

■ Regular Maintenance

- After Water Heater installation is completed, the installation manual should be placed in near the water heater. Maintenance instructions should be carried out by the guidelines. Maintenance detail lists, please refer to the instructions below.

Monthly	Check vent pipe. Check air inlet pipe. Check pressure relief valve. Check condensate drain outlet.
Annually	Check water heater piping (Gas and Water) Check operate pressure relief valve
No plan of use for long-term	Do not disconnect electrical power.

■ Maintenance procedures

- Check installation location
To prevent potential severe personal injury, death or substantial property damage, remove all contaminated materials. If contaminants are found :
Remove products immediately from the area.
In order to check the status of Water Heater, call a qualified service technician to inspect the Water Heater for possible damage from acid corrosion.
DO NOT store combustible materials, gasoline or any other flammable vapors or liquids near the Water Heater. Remove them immediately or store them other places.
- Check if Water heater front cover is closed.
Check if there is any problem with the Water Heater front cover and the two upper and lower screws are tightened well. The Water Heater front cover must be closed while it is running.
- Check power source.
Make sure that the power cord is property connected. The main power line is connected to the manual switch box inside the Water Heater.
- Check status of the control panel.

■ Maintenance procedures [Monthly]

- Check vent pipe.
Visually inspect the flue gas vent piping for any signs of blockage, leakage or deterioration of the piping. Please contact a qualified service technician immediately if you find any problem.
- Check air inlet pipe.
Visually inspect the air inlet piping for obstructions. Inspect entire length of air piping for ensuring that piping is intact and all joints are properly sealed. Call your qualified service technician if you notice any problems.
- Check the condensate outlet.
While the Water Heater is running, check the discharge end of the condensate drain tubing.
Make sure that no flue gas is escaping from the condensate drain tubing.
If flue gas is continuously escaping, it is a serious problem. Call your qualified service technician to inspect the Water Heater and condensate line. Also, refill the condensate trap if problem persists regularly.
- Check vent screen.

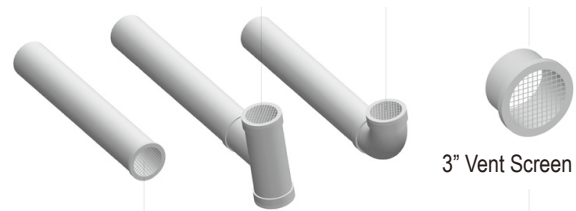



If you encounter a problem of combustion specifications, visually inspect the terminal screen, replace it with spare parts or clean the screens.

2. Cleaning the Water Heater

1. Cleaning Air Intake Filter

To properly maintain the water heater, you should check air intake filter every month. If not, you will encounter a problem with combustion specifications.

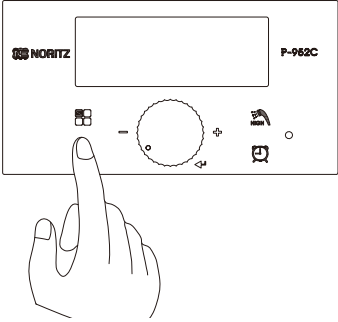
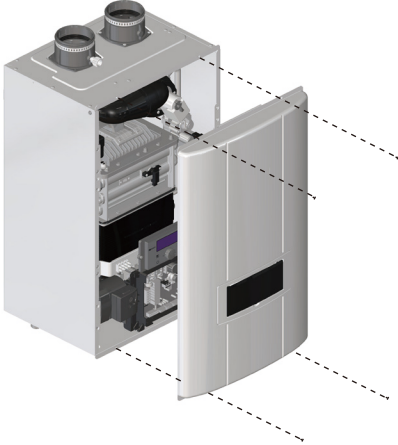
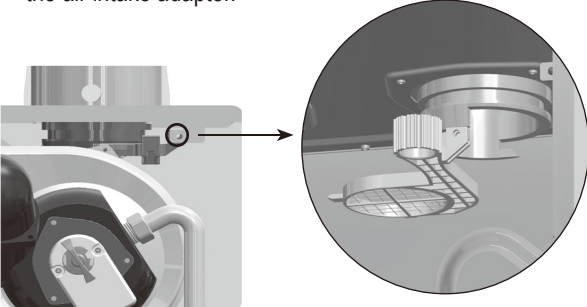
To clean air intake filter:

<p>1. Press the 'Power Button' on the control panel to turn off the water heater. 2. Disconnect the power supply from the water heater. 3. If the water heater has been operating, wait for it to cool before continuing.</p> 	<p>4. Remove the 4 screws on the front cover of the water heater.</p> 
<p>5. Remove the air intake filter screw, then pull the filter out of the air intake adapter.</p> 	<p>6. Clean it with a toothbrush and clean running water.</p> 
<p>7. Dry the filter completely. Then reinsert the filter into the plastic assembly and tighten the filter screen screw. 8. Replace the front cover of the water heater cabinet. Reconnect power supply to the water heater. 9. Press the 'Power Button' on the control panel to turn on the water heater.</p>	

2. When supplying combustion air from the indoors.

To clean air supply vent:

Check for debris or blockage from dust, oil, etc. at the air supply vent. If blocked, remove the build-up with a vacuum cleaner or damp towel. (Do not permanently remove the inlet screen.)

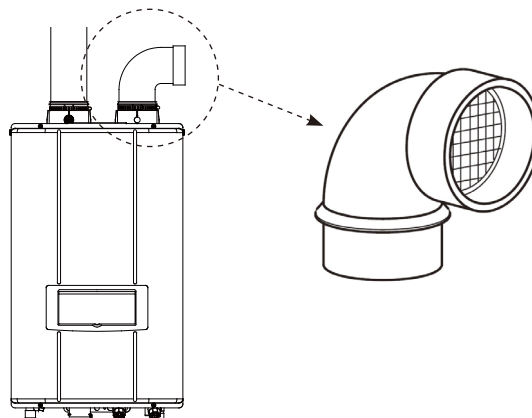

- Cleaning Cold Water Inlet Filter / Recirculation Water Filter

1. Place a bucket under the appliance to collect the residual water inside the water heater.
2. Press the 'Power Button' to turn off the electrical power to the water heater. And then turn off the gas valve.
3. Close water supply valve on the inlet to the appliance.
4. Open the hot water faucets completely.

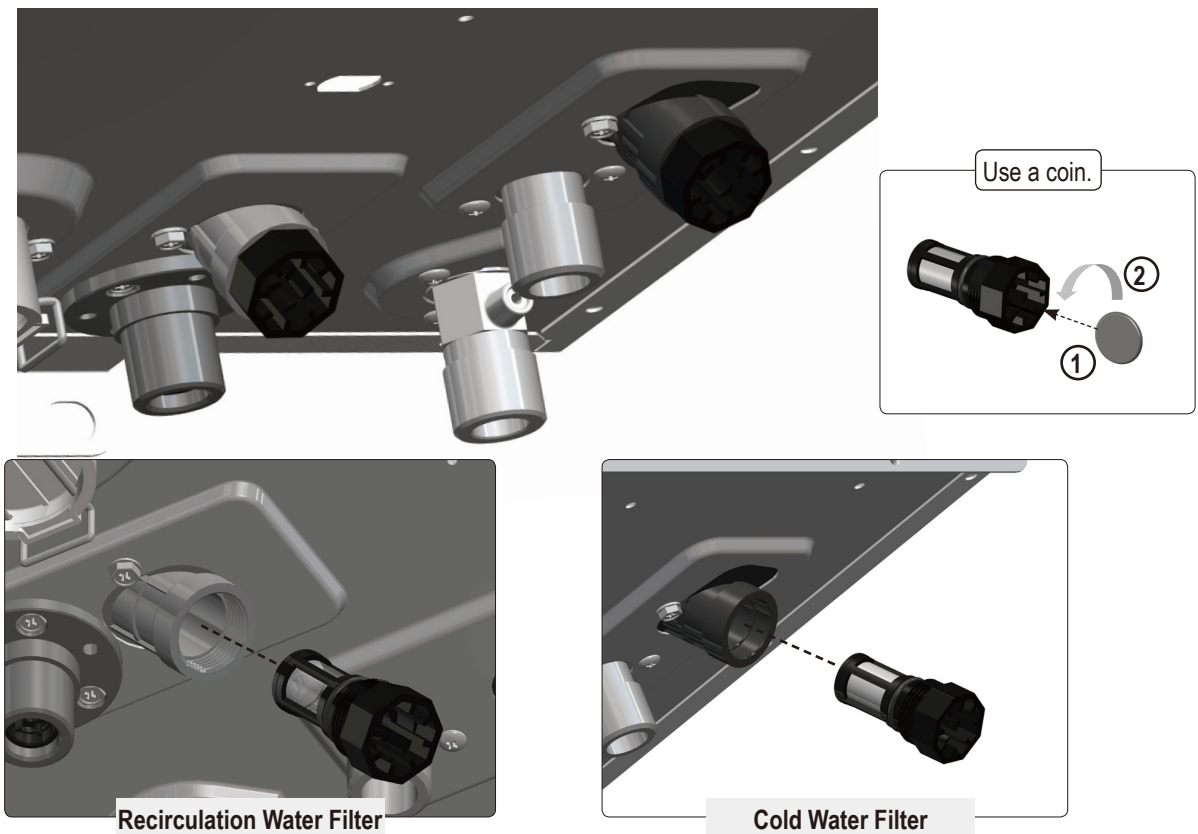

5. Remove the cold water inlet filter and recirculation water filter. And then clean it with a toothbrush and clean running water.

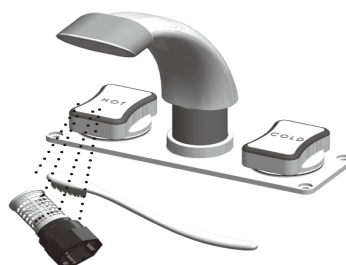

6. To refill the water heater, follow the steps of 'Draining the Water Heater' in reverse.

3. Flushing the Water Heater

- Flushing the Water Heater

Flushing the Heat Exchanger of water heater is a complicated procedure. Initialization is required to do a proper flush. Refer to the following instructions carefully before attempting the procedure. If you do not understand the procedure, contact an authorized technician or licensed professional. Keep in mind that improper maintenance will void your warranty.

■ Regular Cleaning

1. Turn OFF power switch for 10 seconds, then turn back ON. Unit will go through initialization process which may take 25 to 30 seconds. Do not use hot water.
2. Disconnect electrical power (cord) from the unit.
3. Close the shutoff valves on both hot water outlet and cold water inlet lines. (V1 & V2)
4. Connect one hose 'D1' to the valve = 'V3' and place the free end in the bucket. Connect one of the hoses 'D3' to the circulation pump outlet and the cold water inlet line at the valve 'V4'. Connect other hose 'D2' to the circulation pump inlet and place the free end in the bucket.

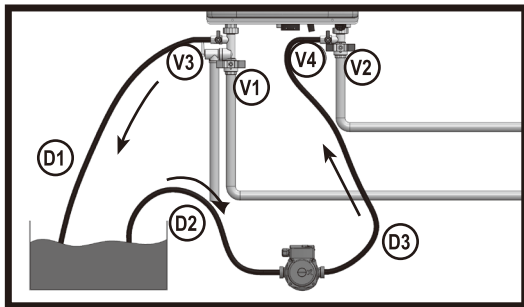

5. Pour the cleaning solution into the bucket. Place the drain hose (D1) and the hose (D2) into the cleaning solution.
6. Open service valves (V3 & V4) on the hot water outlet and cold water inlet lines.
7. Supply inlet water through the water heater for at least 1 hour at a rate of 4 gallons per minute.
8. Rinse the cleaning solution from the water heater as follows:
 - Remove the free end of the drain hose (D1) from the bucket.
 - Close service valve, (V4), and open shutoff valve, (V2). Do not open shutoff valve, (V1).
 - Allow water to flow through the water heater for 5 minutes.
 - Close shutoff valve (V2).

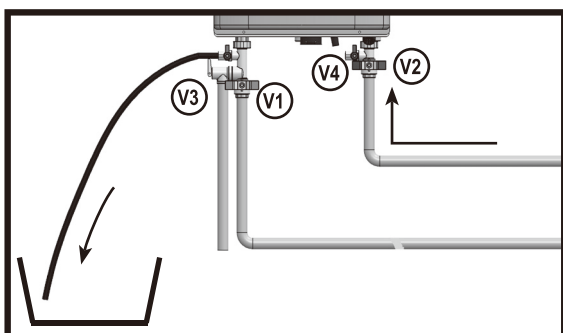

9. Disconnect all hoses.
10. Remove the cold water inlet filter from the water heater and clean out any residues.
11. Reinsert the filter and ensure the filter cap is securely tightened.
12. Connect electrical power to the water heater.

■ Deep Cleaning (In case of Regular Cleaning does not help for Scale issue)

1. Turn off the power to the Control Panel. Press and hold the 'Function Button' for approximately 5 seconds to get into the 'Installer Mode'.

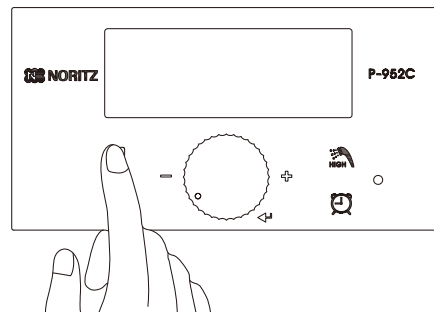

2. In 'Installer Mode,' turn the 'Dial Button' clockwise until the display reads [13:CK] and press the 'Dial Button'. Then turn the 'Dial Button' clockwise to select 'b.PP2'.

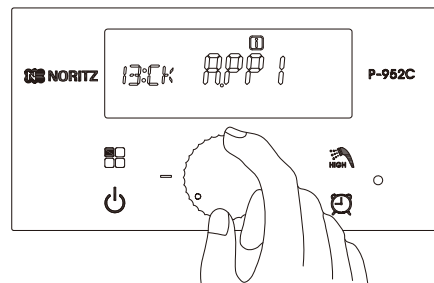

3. Press the 'Dial Button' when the 'b.PP2' is flashing.

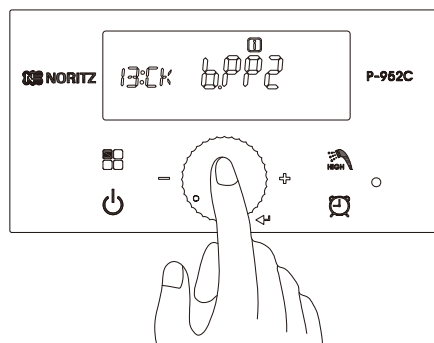

4. Turn the 'Dial Button' clockwise to select 'on'.

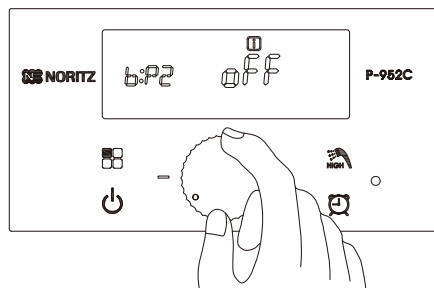

3. Flushing the Water Heater

5. Press the 'Dial Button' and confirm the pump activation by sounds and also icon on the Control Panel.

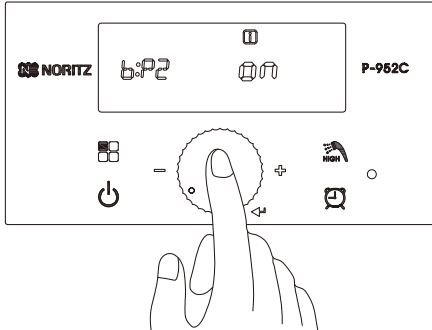

6. Wait for 30 seconds and disconnect the power to the water heater.
7. Follow from 3 to 12 in regular cleaning above to finish the cleaning.

■ Maintenance procedures [Annually]

- Check piping (gas and water)

Visually inspect for leaks around internal water piping. Also inspect external water piping, circulators, pressure relief valve and fittings. Immediately call a qualified service technician to repair any leaks.

Leaks must be fixed by a qualified service technician immediately. Failure to comply with this instruction could result in severe personal injury, death or substantial property damage.

- Check for operation of the pressure relief valve

⚠ WARNING

Leaks must be fixed by a qualified service technician immediately. Failure to comply with this instruction could result in severe personal injury, death or substantial property damage. This discharge line must be installed by a qualified heating installer or a service technician.

Before proceeding, verify that pressure relief valve outlet has been piped to a safe place of discharge, avoiding any possibility of scalding from hot water. If water flows freely, release the lever and allow the valve to seat. Watch the end of the pressure relief valve discharge pipe to ensure that the valve does not weep after the line has had time to drain. If the valve weeps, lift the seat again to attempt to clean the valve. If the valve continues to weep, contact your qualified service technician for inspecting the valve and system. If water does not flow from the valve even though you have lifted the lever completely, the valve or discharge line may be blocked. Shut down the Water Heater immediately. Call your qualified service technician to inspect the water heater and system.

- Check burner state

You can clean the exterior of burner. However, if you need to clean the inside of the burner, you should call an qualified service technician.

4. Checking for Error Conditions

When the water heater encounters an error, the display will flash ‘Er’ followed by a numerical code. The water heater shall enter a soft lockout condition if the error is such that it can return to normal operation once the condition relieves itself (overheat conditions, temperature sensor open or shorts, etc.). The water heater shall enter a hard lockout if the condition indicates the unit detected a condition preventing safe operation (Er.11_Ignition, Er.29_Air pressure switch abnormality, Er.40_Gas leakage) To clear a hard lockout Error Code press the ‘Power Button’ off then on.

The following screen will display when the water heater encounters an error.

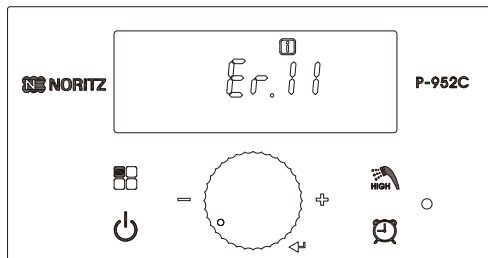

Error Code	Error Code Description	Possible Remedies
Er:11	Ignition has failed 10 (Ten) times	<p>Press the Power button to clear the Error Code. If error code still appears on the display then check the following.</p> <ul style="list-style-type: none"> • Make sure that the gas valve is in the fully open position. <p>If Error happens again: Contact the installer or Noritz America Technical Support for assistance.</p>
Er:29	Air pressure switch abnormality	<p>Press the Power button to clear the Error Code. If error code still appears on the display then check the following.</p> <ul style="list-style-type: none"> • Make sure that the exhaust pipe is free of obstructions. • Clean the intake air filter. • Make sure that there is no clog of condensate trap or drain pipe. <p>If Error happens again: Contact the installer or Noritz America Technical Support for assistance.</p>
Er:40	Gas Leakage is detected in 10 Minutes, or three times within one Hour (Greater than 5 seconds each time)	<p>IMPORTANT: If you smell gas, STOP! Follow the instructions on page 4, this guide, and call a qualified service technician or the gas utility.</p> <p>Press the Power button to clear the Error Code.</p> <p>If Error happens again:</p> <ul style="list-style-type: none"> • Check the water heater cover. Ensure it is secure. • Check gas connections for leakage with a soapy solution. Fix any leaks. • Check condition of the burner assembly. • If the problem persists, replace the circuit board.
Er:44	Possible pump failure	<ul style="list-style-type: none"> • Check pump.
Er:45	Water leakage is detected in water heater.	<p>Press the Power button to clear the Error Code. If error code still appears on the display then check the following.</p> <ul style="list-style-type: none"> • Check for the water in the bottom of the heater inside the case. <p>If you have confirmed the water leak, the water valve/gas valve closes and contact the installer or Noritz America Technical Support for assistance.</p>
Er 46	Low recirculation flow	<ul style="list-style-type: none"> • Check return and cold water filters. • Verify recirculation loop length is within specification. • Check the pump operation. • Check recirculation setting. (External or On-Demand setting without dedicated return line. External or On-Demand setting with crossover valve)

Contact Noritz America at 866-766-7489

- Any other error code appears.
- An error code is indicated again after the above actions were followed.
- There are any other questions.

Troubleshooting

Problem	Possible Remedies
Burner Does Not Ignite	<ul style="list-style-type: none"> • Make sure that the ON/OFF button on the Control Panel is ON. • If the display on the Control Panel is blank, make sure the power cord is plugged in and 3A fuses on the main controller in the water heater are good. Power switch inside water heater is on. • Make sure that the water heater is supplied with water. The unit activates when inlet water flow sensor detects flow over 0.5 gpm • Make sure the cold and hot water lines are not plumbed in reverse. • Ensure the cold water and gas supply lines are open. • Make sure the water lines are not frozen.
Water is Not Hot Enough	<ul style="list-style-type: none"> • Ensure the temperature setting on the water heater is not too low. • Ensure the filter in the cold water supply line is not clogged with debris. • Make sure the water heater is connected to the correct gas supply.
Water is Too Hot	<ul style="list-style-type: none"> • Ensure the temperature setting is not too hot. • Ensure the filter in the cold water supply line is not clogged with debris. • Make sure the water heater is connected to the correct gas supply.
Hot Water Temperature Fluctuates at Tap	<ul style="list-style-type: none"> • Ensure the filter in the cold water supply line is not clogged with debris. • Make sure the water heater is connected to the correct gas supply.
The Blower Continues to Operate After Combustion Stops	<ul style="list-style-type: none"> • This is normal. The blower operates for three minutes after combustion has stopped to purge remaining exhaust gas from the flue.
Cannot Change the Hot Water Mode Setpoint above 120°F	<ul style="list-style-type: none"> • This is a safety device to prevent scalding. Hot water temperature over 125°F can cause instant severe burns or death.
The Water Heater Makes Abnormal Sounds During Operation	<ul style="list-style-type: none"> • Ensure the venting installation complies with the installation manual. • Ensure supply gas pressure is sufficient. Insufficient gas pressure will cause unstable burner flame and noise.

Water Quality

Damage to the water heater as a result of poor water quality is not covered by the Limited Warranty. To ensure full warranty coverage, treat or condition water that exceeds the target levels provided in this table.

(Source: EPA National Secondary Drinking Water)

Total Hardness*	200 mg/L (12 gpg) or less
Aluminum	0.05 to 0.2 mg/L or less
Chloride	250 mg/L or less
Copper	1 mg/L or less
Iron	0.3 mg/L or less
Manganese	0.05 mg/L or less
pH	6.5 - 8.5
Total Dissolved Solids	500 mg/L or less
Zinc	5 mg/L or less
Sulfate ion	250 mg/L or less
Residual chlorine	4 mg/L or less

* Maximum limit suggested by Noritz.

Follow-up Service

Requesting Service

First follow the instructions in the troubleshooting section (p.38 to p.39).

If the error is not corrected, contact Noritz America Technical Support at 866-766-7489.

We will need to know:

The Model(check the rating plate)

Date of purchase(see the warranty)

Details of problem(flashing error codes,
etc., in much detail as possible)

Your name, address, and telephone number

Desired date of visit

A request for service may be rejected if the water heater is installed in a location where working on the unit may be dangerous. Contact a plumber.

Warranty

A warranty registration card is included separately.

Be sure that the plumber, date of purchase and other necessary items are filled in.

Read the content carefully, and keep the warranty card in a safe place.

For repairs after the warranty period, there will be a charge on any service, and service will only be performed if the unit is deemed repairable.

Period of Time for Stocking Repair Parts

Noritz will stock repair and maintenance parts for this unit for the time period from the date of the original installation or end of production as follows: twelve (12) years for the heat exchanger and ten (10) years for remaining parts.

Owner's Guide

Register your Warranty online at www.noritz.com/warranty



NORITZ AMERICA CO.
11160 Grace Avenue Fountain Valley, CA 92708
Phone : 866 - 766 - 7489